

GRAND

Writing desk

СТОЛ ПИСЬМЕННЫЙ

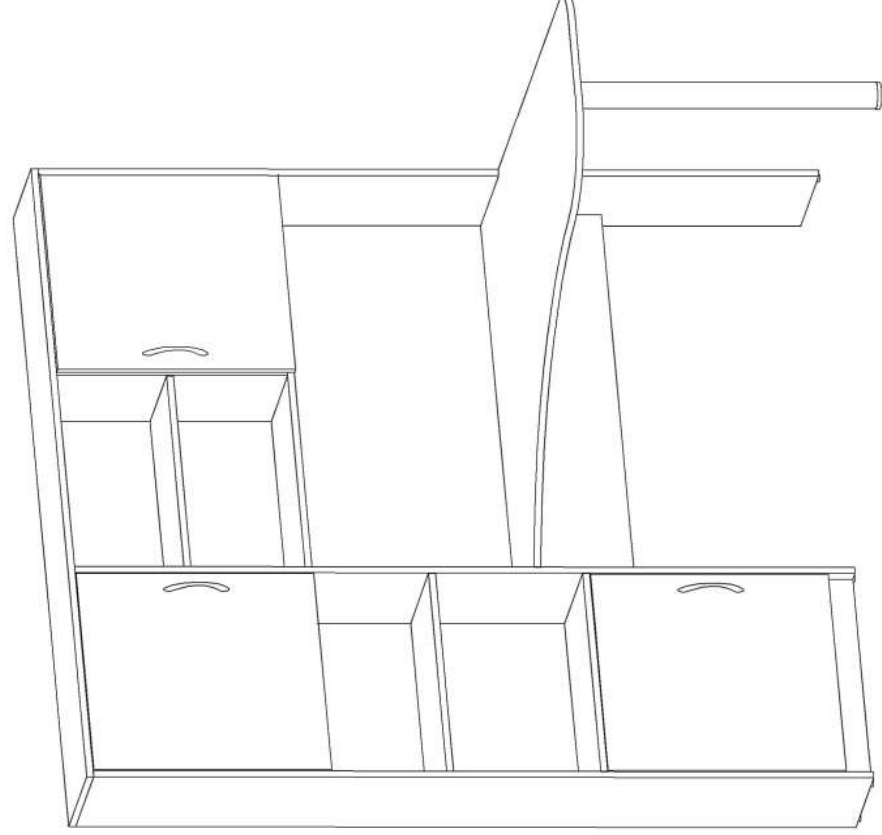

You  [Tube.com/amimebelby](https://www.youtube.com/amimebelby)



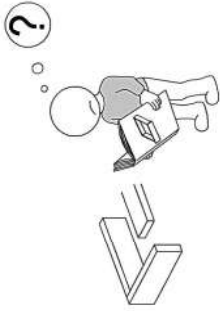
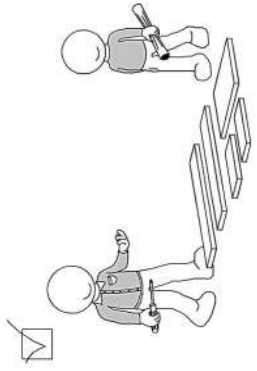
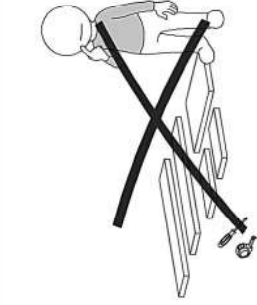
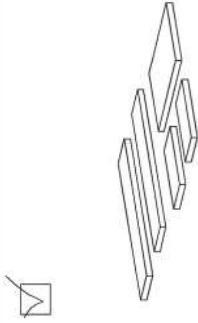
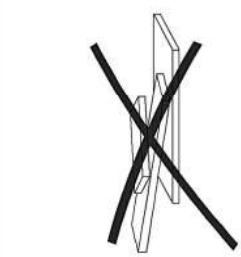
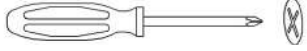
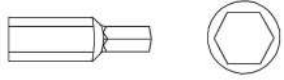
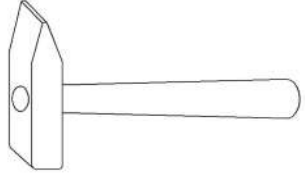
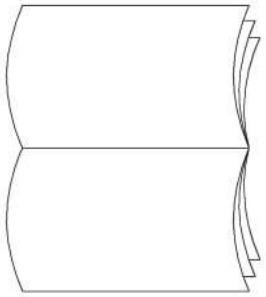

YouTube.com/amimebelby

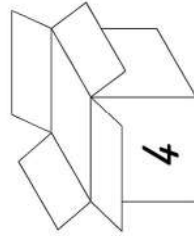
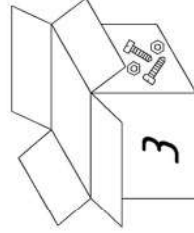
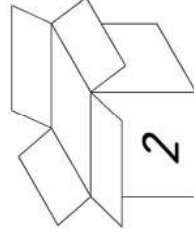
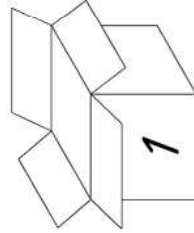
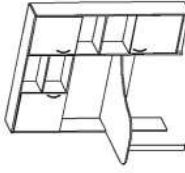
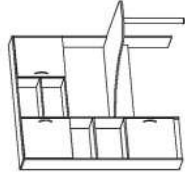
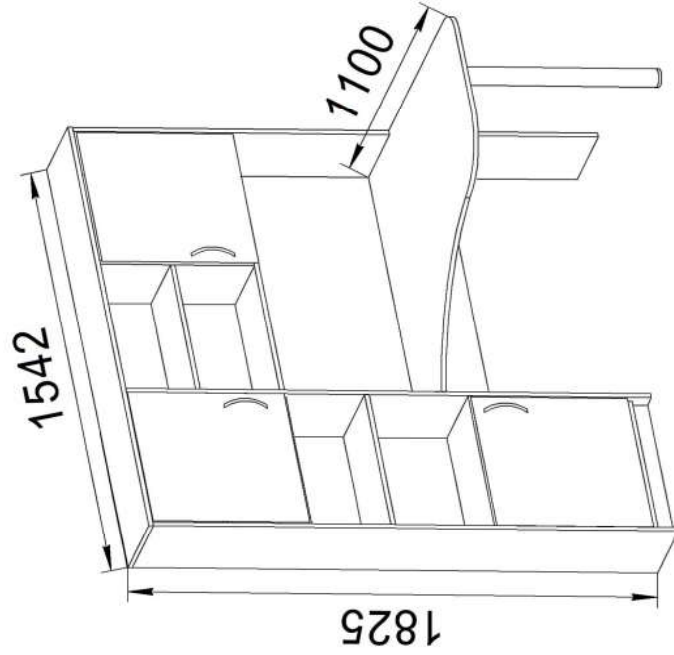
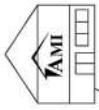
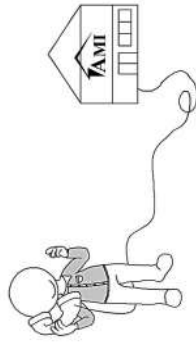

Nº	a x b x c	n
1	1804x250x16	1
2	1804x250x16	1
3	710x350x16	1
4	1542x250x16	1
5	1050x1100x16	1
6	470x230x16	2
7	470x230x16	2
8	556x230x16	1
9	470x230x16	1
10	470x60x16	1
11	1024x260x16	1
12	538x230x16	1
13	452x230x16	1
14	1024x230x16	1
15	470x230x16	1
16	1078x250x16	1
17	550x466x16	3
18	498x566x3	2
19	480x566x3	1

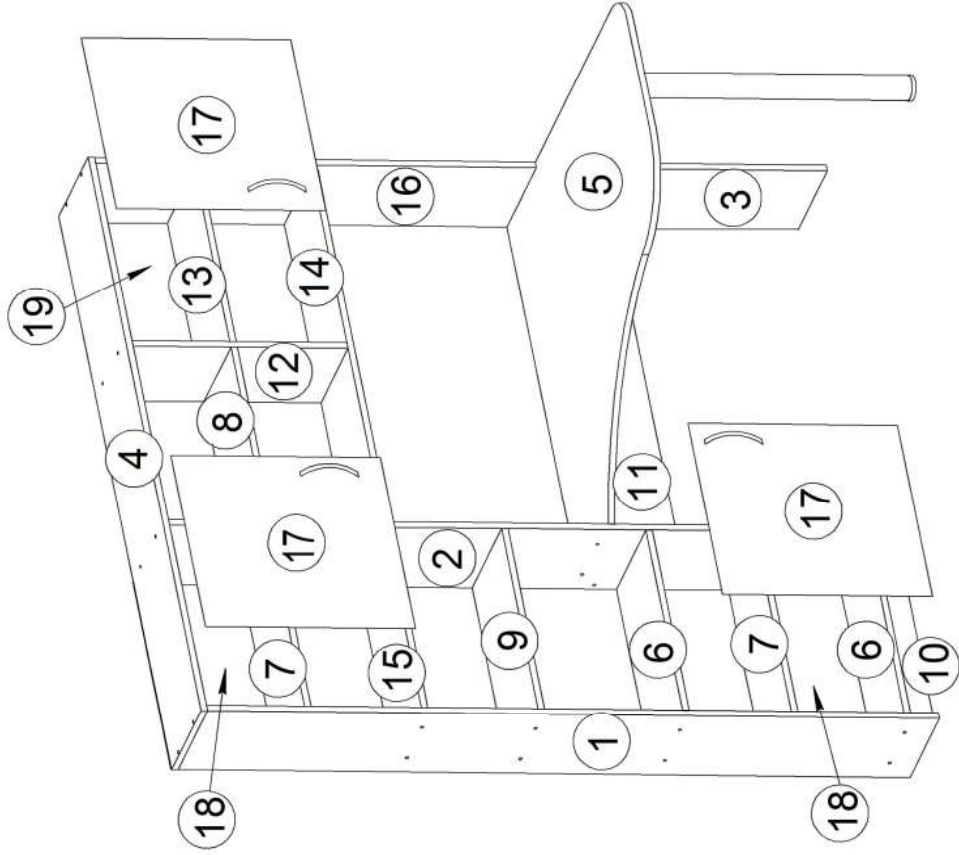
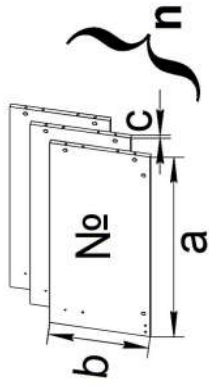
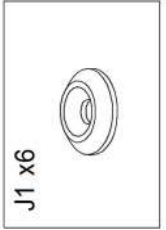
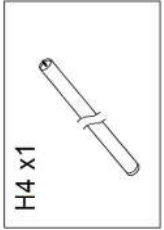
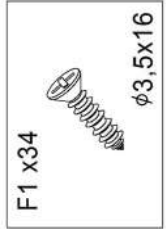
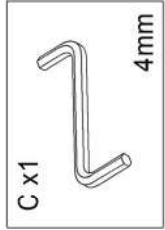
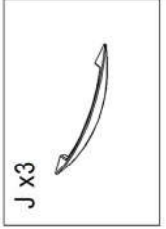
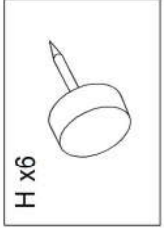
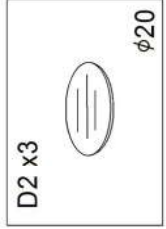
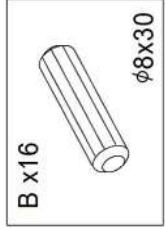
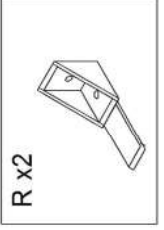
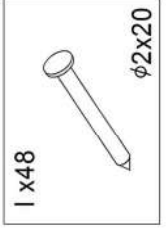
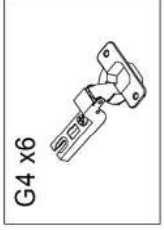
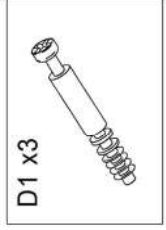
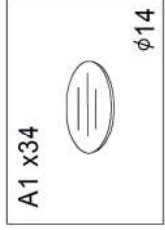
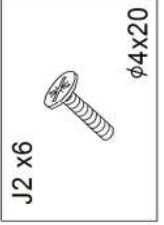
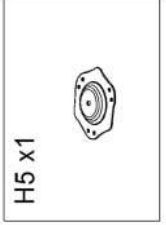
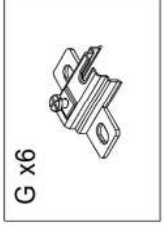
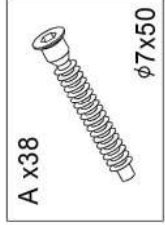

12

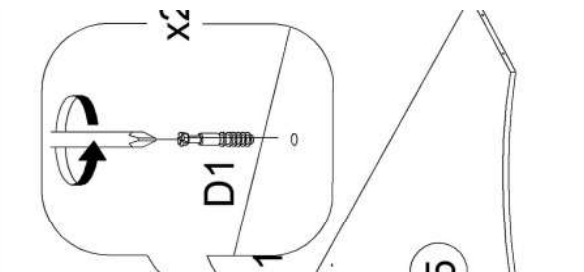
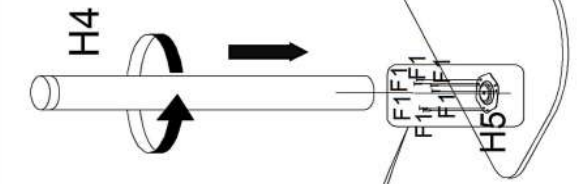
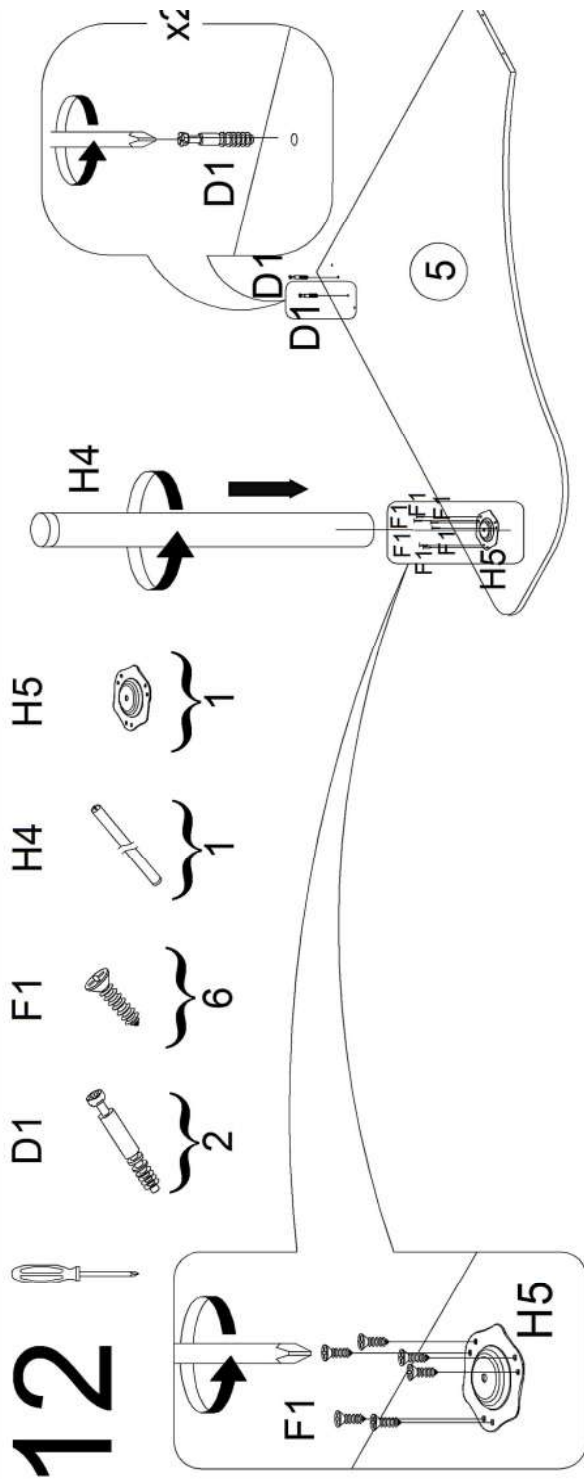

13

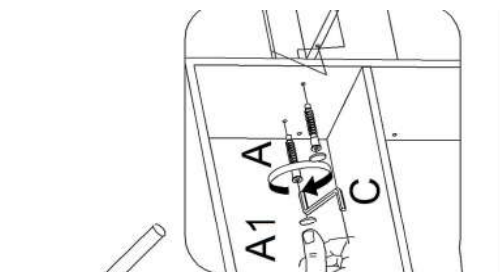
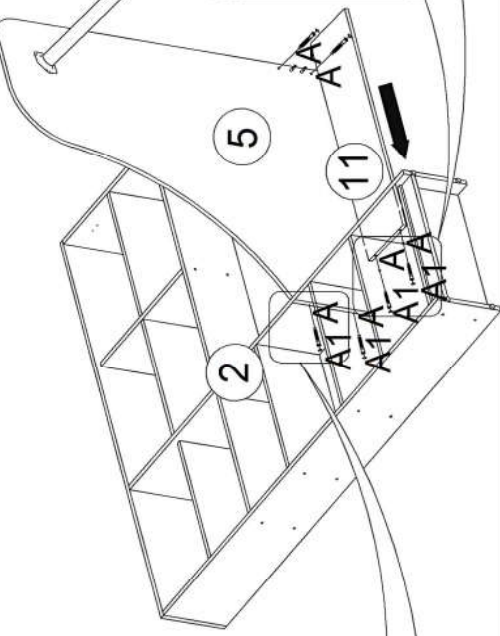
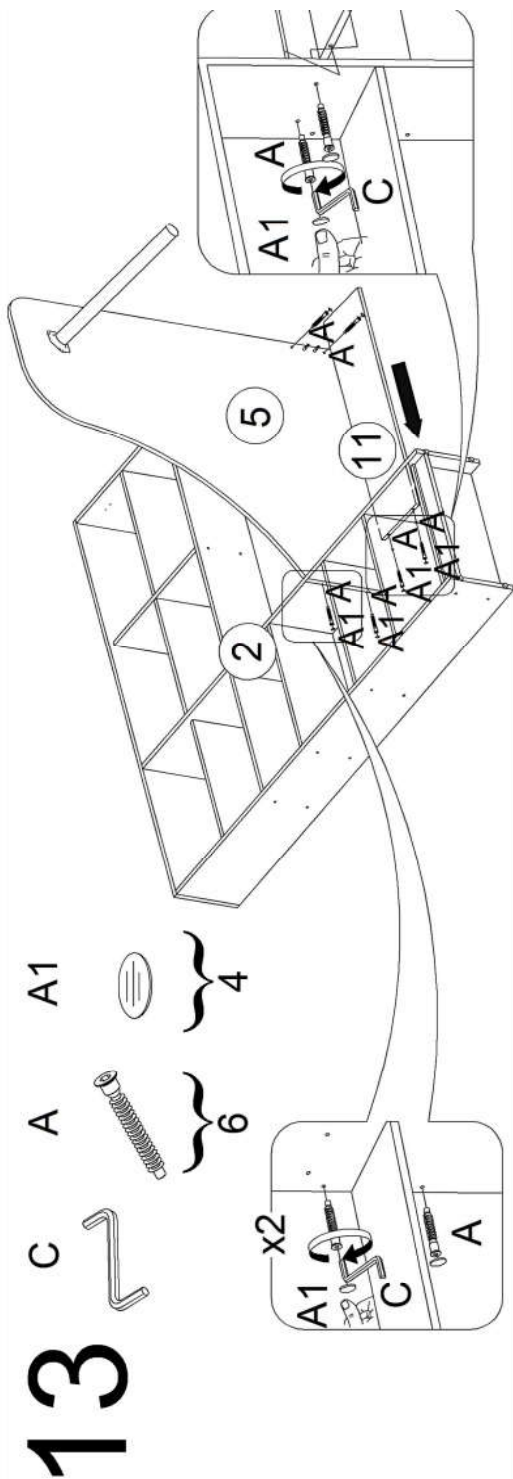

14

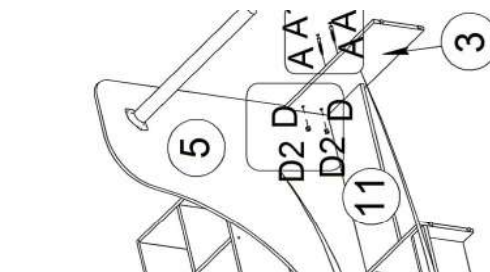
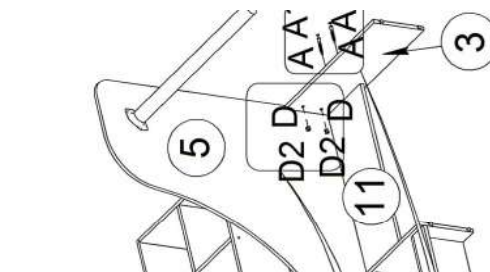
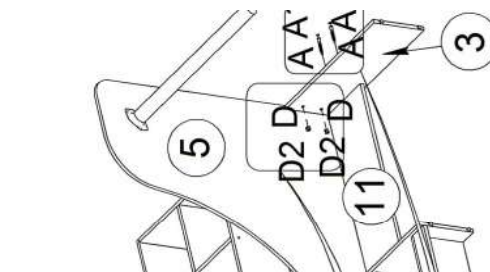
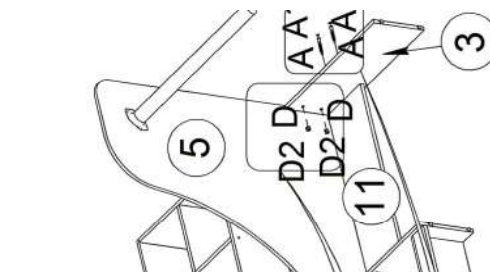
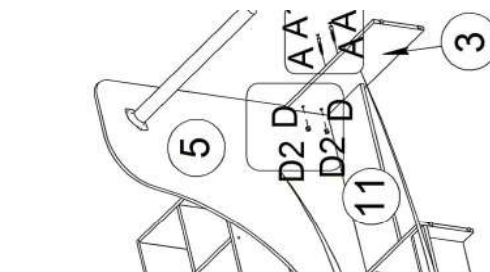
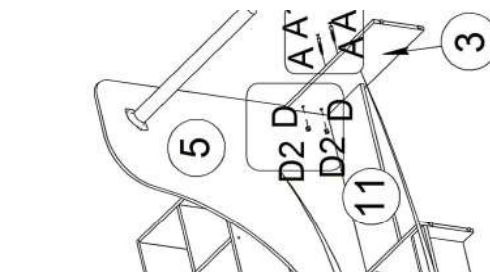
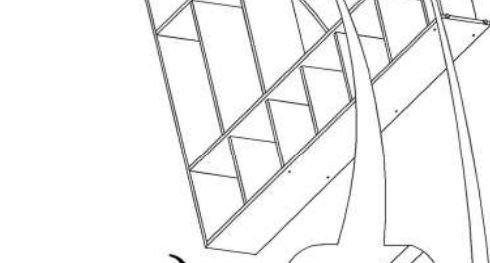
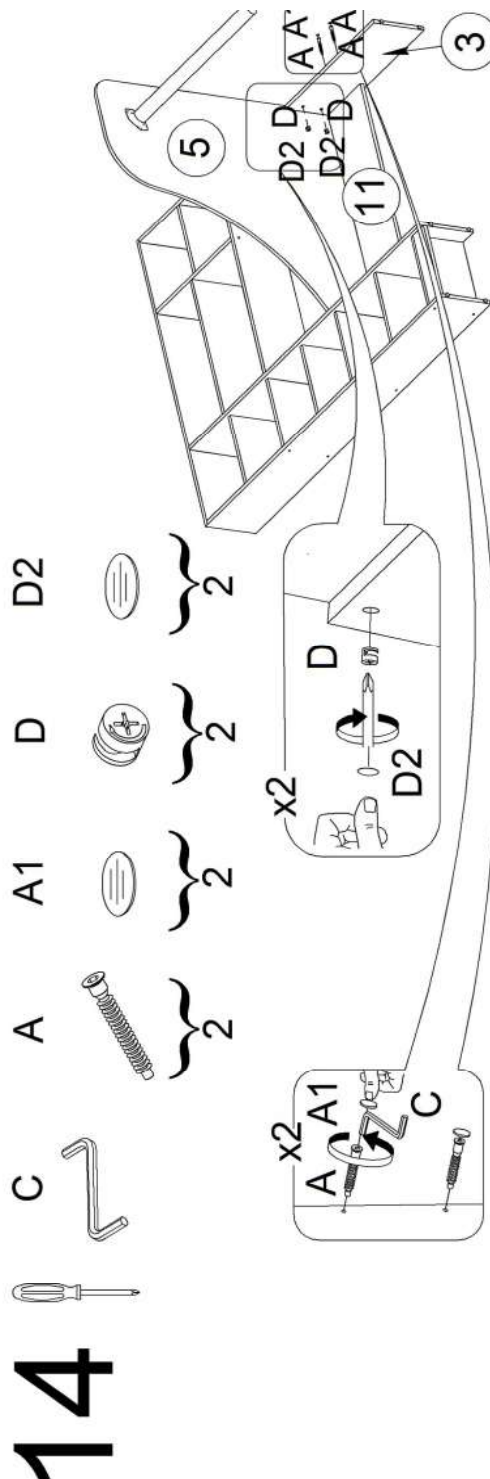

15

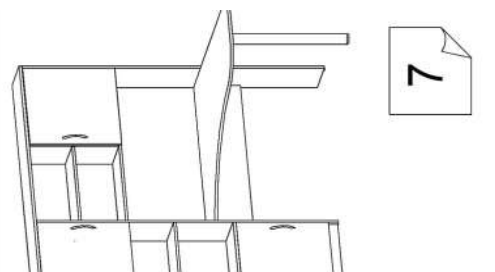
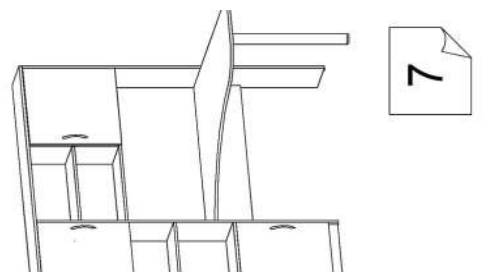
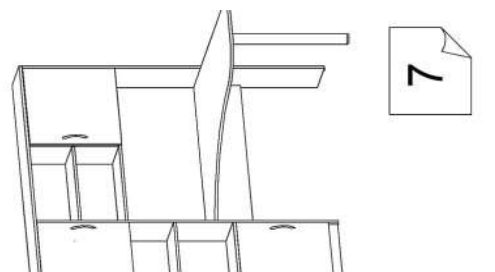
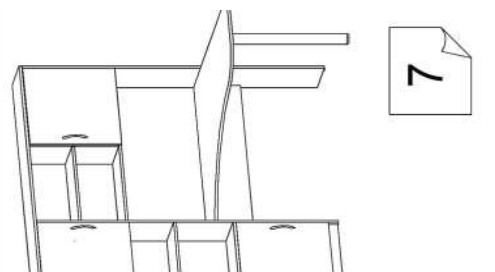
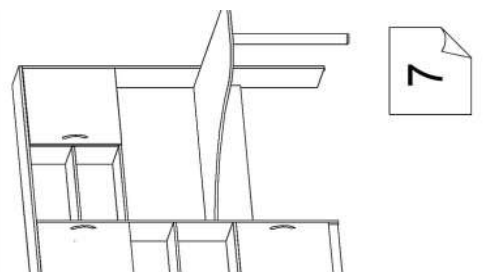
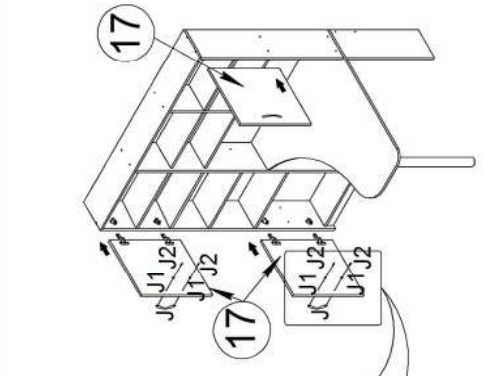
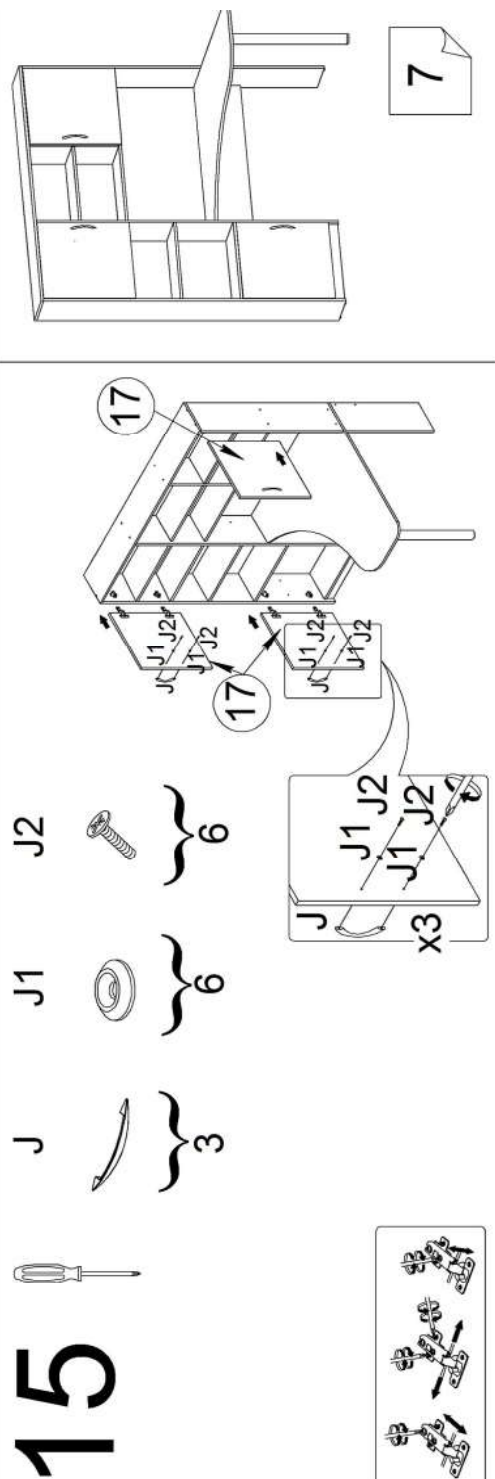

7

4

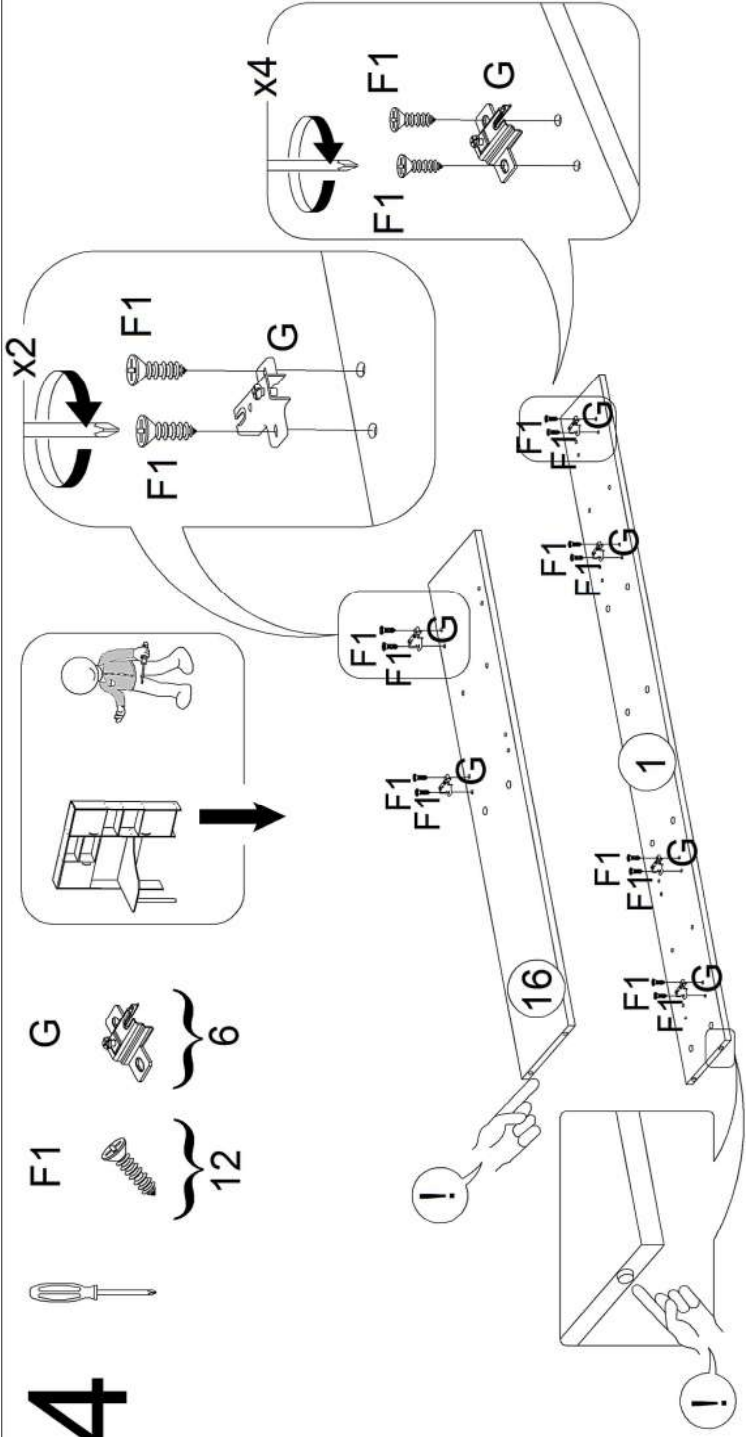
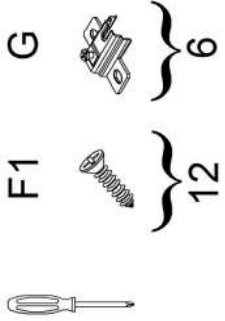

5

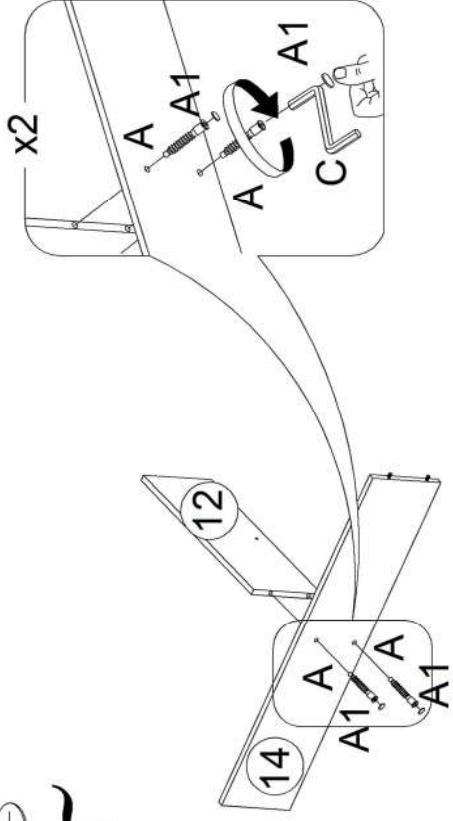
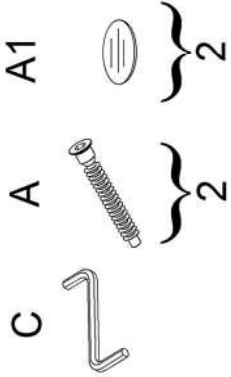

6

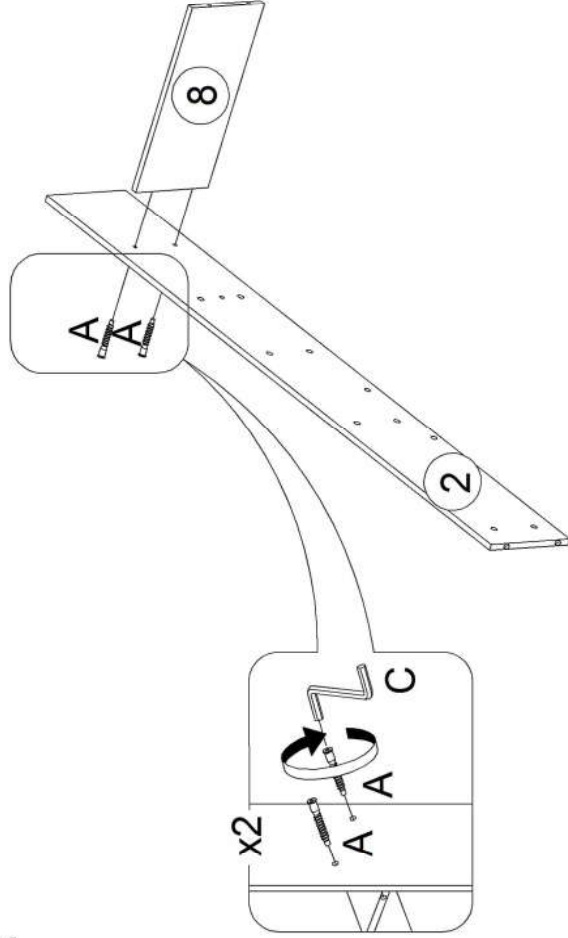
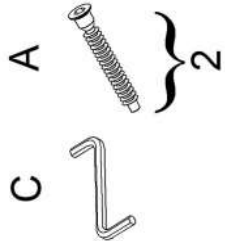

8

7

C A A1 D1

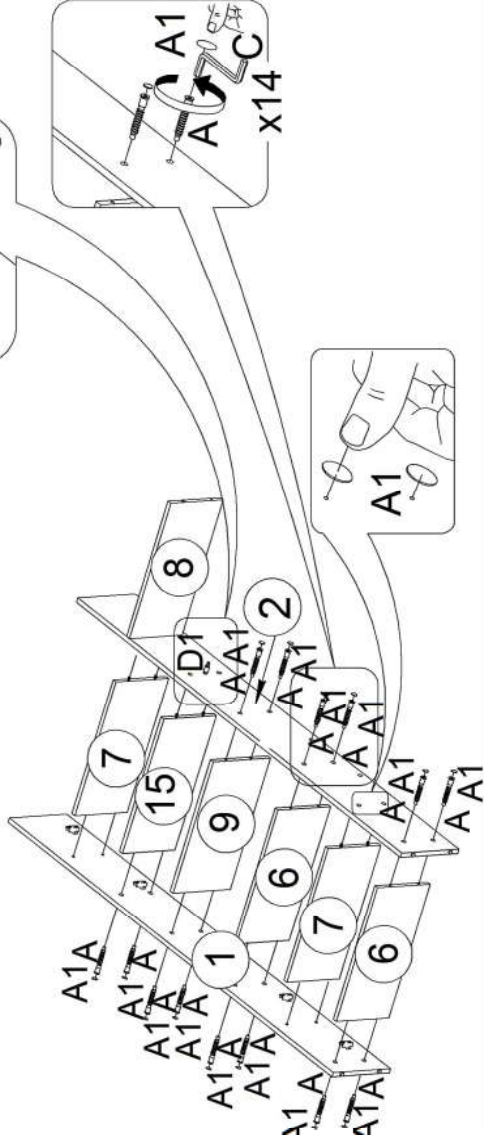
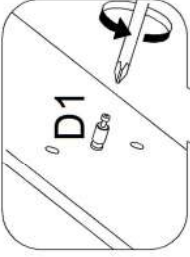
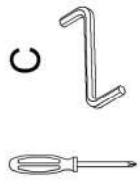

8

C A D D2

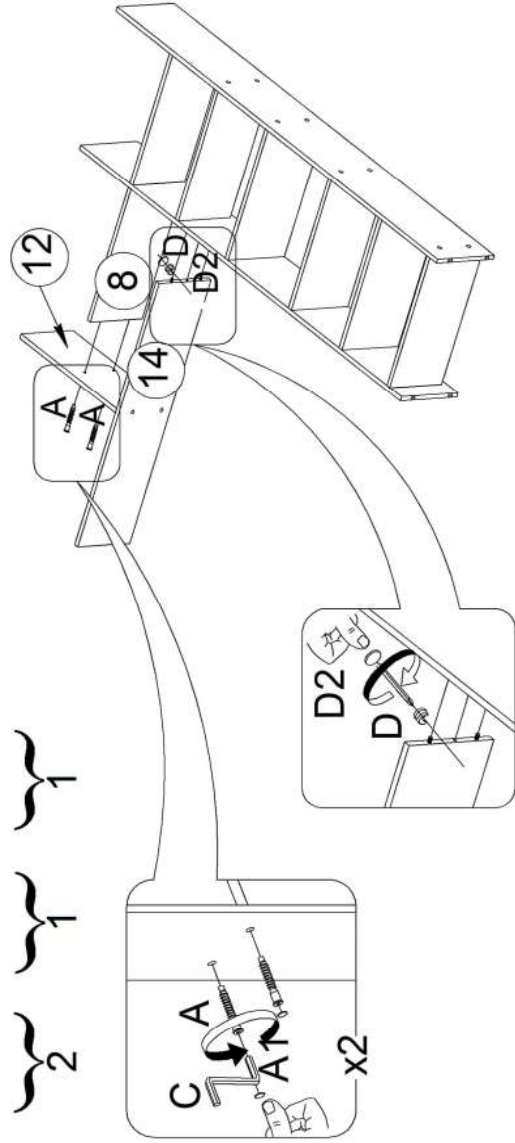
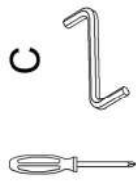

9

C A A1

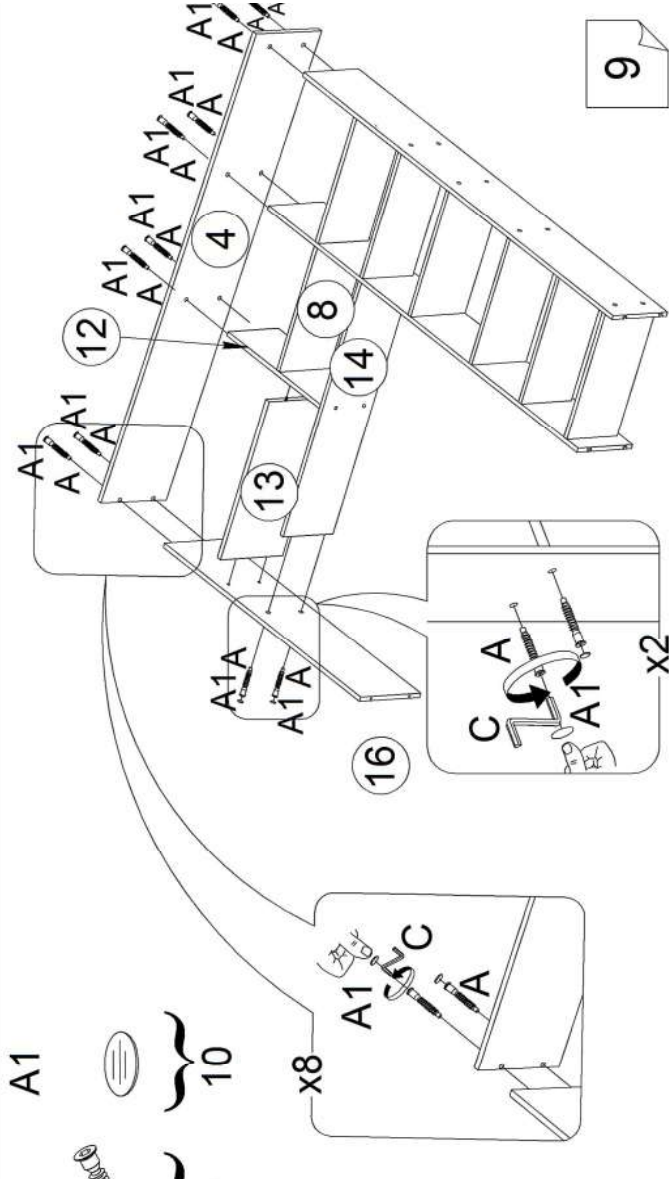
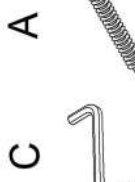

9

11

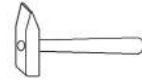

L1 L3

L1=L2
L3=L4

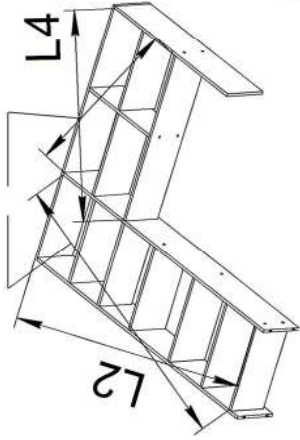

x48

L2

L4

50

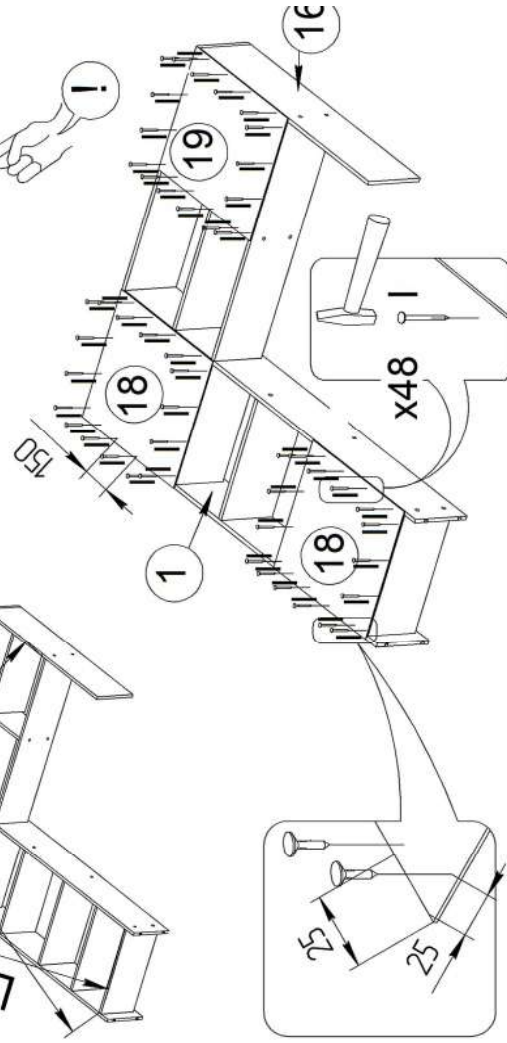

12

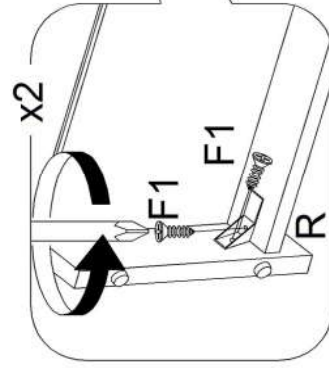

x2

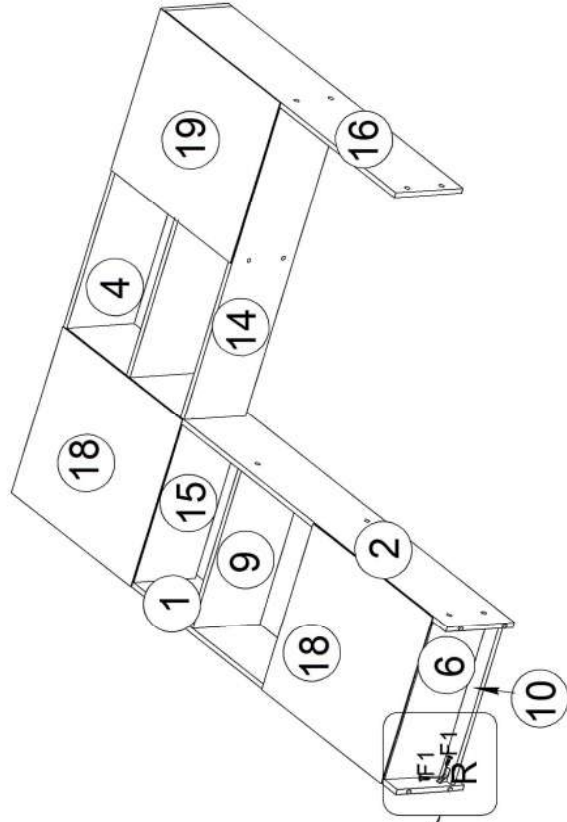

13

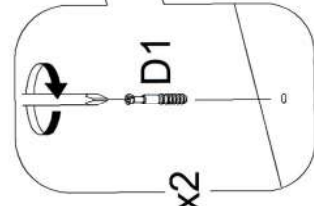

x2

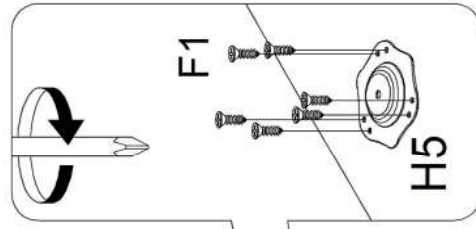
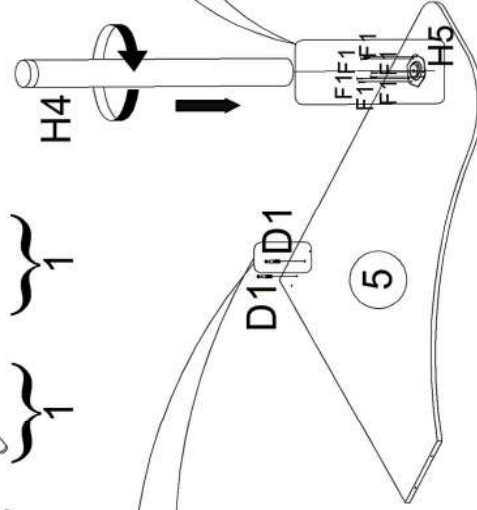

14

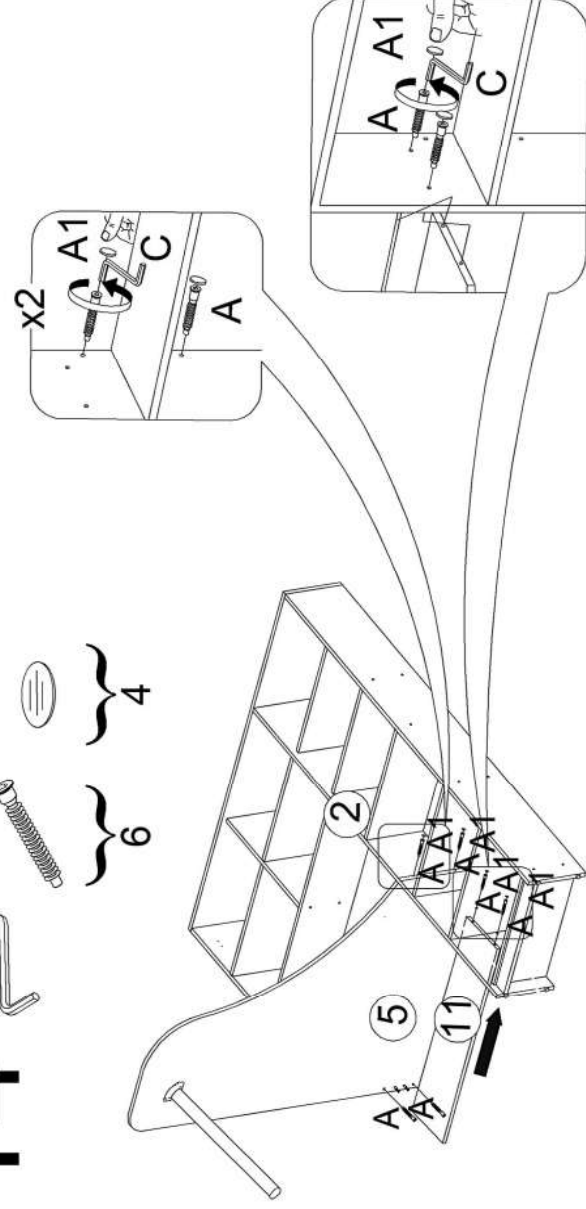
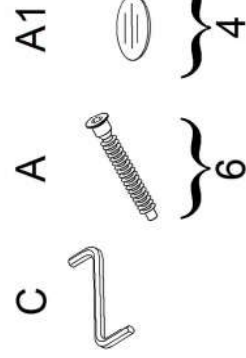

15

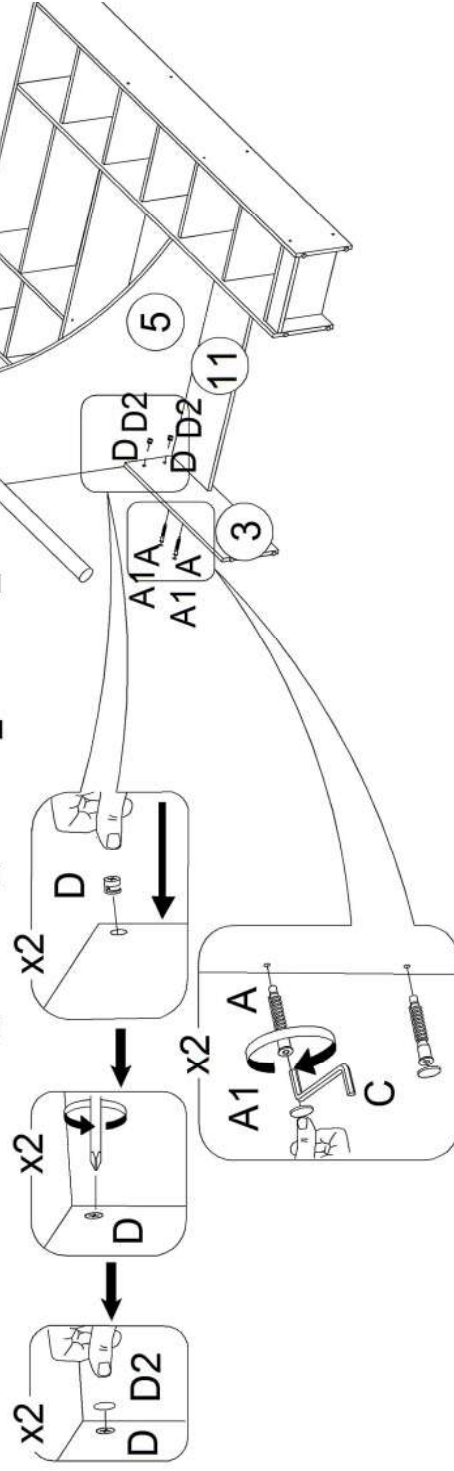
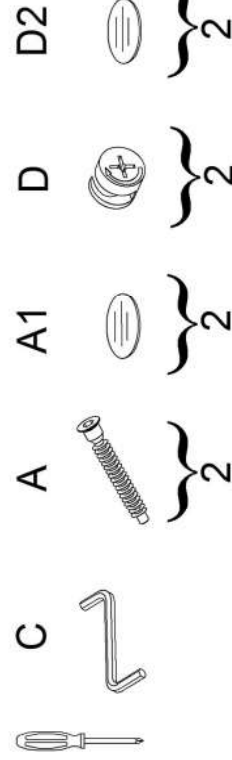

16

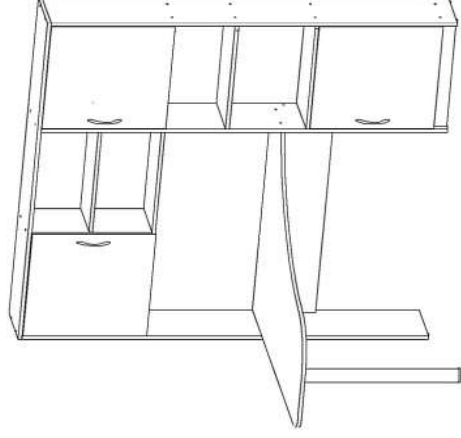
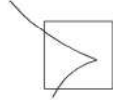
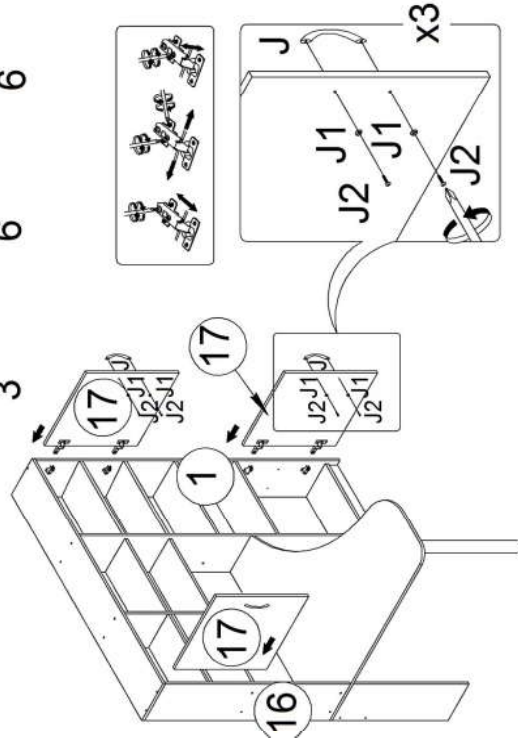
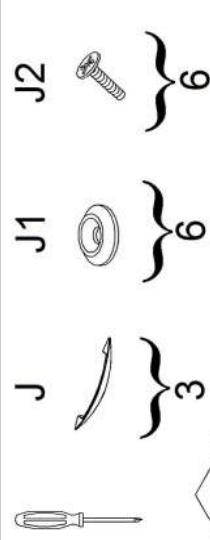



ПРАВИЛА И УСЛОВИЯ БЕЗОПАСНОЙ ЭКСПЛУАТАЦИИ

1. Использование мебельной продукции, выпущенной в обращение, должно осуществляться по назначению изделия мебели, указанному в маркировке, инструкции по сборке, эксплуатации и уходу.
2. Мебельная продукция, поставляемая в разобранном виде, должна собираться специалистом по сборке мебели на ровной (выровненной по уровню) поверхности в соответствии с приложенной изготовителем инструкцией по сборке, включающей комплектующую ведомость и схему монтажа.
3. При установке изделий мебели в непосредственной близости от нагревательных и отопительных приборов их поверхности во время эксплуатации должны быть защищены от нагрева. Температура нагрева элементов мебели не должна превышать +40°C.
4. Не допускается разделять и резать продукты на поверхности столешниц кухонных столов.
5. При размещении мебели в квартире в холодный период времени, перед её сборкой, необходимо выдерживать детали при комнатной температуре не менее двух часов.
6. В процессе эксплуатации изделий необходимо периодически проверять и затягивать ослабленные болтовые и винтовые соединения, в шкафах-купе «Комфорт» периодически проверять и затягивать ослабленные соединения на механизмах раздвижения дверей.
7. В угловых шкафах с боковой стенкой 400 мм функциональное пространство с закреплённой царгой разделено на часть для хранения одежды и часть для хранения гаслуков, ремней.
8. Двери шкафов в процессе установки и перемещения к месту установки должны подаваться строго в положение («на ребро»).
9. В случае необходимости перемещения изделия в помещении нужно полностью освободить мебель от хранящихся вещей и предметов, выдвигаемые полок и ящиков. Во избежание поломки имеющихся опор передвигание производить приподнятым изделием над уровнем пола.
10. Не допускается статическая вертикальная нагрузка (в особенности с приложением усилия в одной точке): на дно ящика - более 5 кг, на полки шкафов, стеллажей - более 10 кг, подставок и столов кухонных - более 60 кг, столов письменных, компьютерных и обеденных - более 75 кг. Нормальное усилие открытия дверей - до 5 кг, усилия выдвигания ящиков - до 5 кг. Нагрузка на стеклянные полки не должна превышать 2,5 кг.
11. Допустима предельная нагрузка на одно спальное место кровати, кровати двуярусной и кровати-чердака - не более 90 кг. Не рекомендуется вставать ногами на изделие, сидеть на спинке и боковых частях мебели.
12. Предприятие-изготовитель оставляет за собой право вносить изменения в конструкцию изделия, не ухудшая его конструктивные и эксплуатационные характеристики.

ПРАВИЛА УХОДА ЗА МЕБЕЛЬЮ

1. При эксплуатации мебельной продукции необходимо исключить попадание воды и иных жидкостей на элементы изделий мебели. При монтаже моек, раковин в изделиях мебели для кухни, ванных комнат должна быть предусмотрена их гидроизоляция в местах контакта с поверхностью корпуса изделия мебели.
2. Удаление пыли с изделий следует производить слегка влажной либо специальной сухой салфеткой без применения химических чистящих средств.
3. Во избежание коробления и изменения цвета мебели следует избегать попадания прямых солнечных лучей на ее поверхность.
4. Мебель рекомендуется эксплуатировать в помещениях при температуре не менее +2°C и относительной влажности 45-70%.
5. Запрещается ставить горячие предметы на все крышки и горизонтальные поверхности изделий, размораживать продукты или оставлять на длительное время на поверхности столешницы сильно охлажденные предметы.

ГАРАНТИЙНЫЕ УСЛОВИЯ ИЗГОТОВИТЕЛЯ

Гарантийный срок эксплуатации изделия:
Мебель - 24 месяца со дня продажи магазином. Изделие соответствует требованиям ГОСТ 16371-2014.
Мебель для сидения и лежания - 18 месяцев со дня продажи магазином.
Изделие соответствует требованиям ГОСТ 16371-2014, ГОСТ 19917-2014.
В период гарантийного срока изготовитель гарантирует ремонт изделий или их замену, если потребителем не нарушены правила эксплуатации.
Срок службы мебели и мебели для сидения и лежания - 2 года.

Отдел экспорта: +375 (163) 63-34-64
e-mail: info@laguna.by
Отдел гарантийного обслуживания: +375 (163) 40-29-07
+375 (33) 333-56-23
+375 (44) 780-17-76
e-mail: remont@ami.by

www.AMI.by

Export department: +375 (163) 63-34-64
Warranty e-mail: info@laguna.by
service department: +375 (163) 40-29-07
+375 (33) 333-56-23
+375 (44) 780-17-76
e-mail: remont@ami.by

RULES AND CONDITIONS FOR SAFE OPERATION

1. The use of furniture products released into circulation must be carried out according to the purpose of the furniture product indicated in the marking, assembly instructions, operation and care.
2. Furniture products delivered in disassembled form must be assembled by a furniture assembler on a flat (level-aligned) surface in accordance with the assembly instructions attached by the manufacturer, which include a complete list and installation diagram.
3. When installing furniture products in the immediate vicinity of heating and heating devices, their surfaces must be protected from heat during operation. The heating temperature of furniture elements must not exceed +40°C.
4. It is not allowed to carve and cut products on the surface of the worktops of kitchen tables.
5. When placing furniture in an apartment during a cold period of time, before assembling it, it is necessary to keep the parts at room temperature for at least two hours.
6. Check and tighten loose bolt and screw connections periodically during operation of products; in sliding wardrobe "Comfort", check and tighten loose connections on the door sliding mechanisms periodically.
7. Corner cabinets with 400 mm sidewall are divided into a functional space with a fixed rail into a part for storing clothes and a part for storing ties and belts.
8. Cabinet doors during installation and moving to the installation site must be supplied strictly in the "sideways" position.
9. If you need to move the product in the room, you need to completely free the furniture from stored items and objects, pull-out shelves and drawers. To avoid damage to the existing supports, move the product by lifting it above the floor level.
10. Static vertical loads (especially single point forces) are not permissible: more than 5 kg on the bottom of the drawer, more than 10 kg on the shelves of cabinets, shelving units, more than 60 kg on stands and kitchen tables, more than 75 kg on desks, computer and dining tables. The normal force of opening doors is up to 5 kg, drawer pull-out force up to 5 kg. The load on the glass shelves should not exceed 2,5 kg.
11. The maximum permissible load for one berth of a bed, bunk bed and loft bed is not more than 90 kg. It is not recommended to stand with your feet on the product or sit on the back and sides of the furniture.
12. The manufacturer reserves the right to modify the product without impairing its construction and performance.

FURNITURE CARE INSTRUCTIONS

1. When using furniture products, the ingress of water and other liquids into the furniture parts must be avoided. When installing sinks and basins in kitchen and bathroom furniture products, they must be waterproofed where they come into contact with the surface of the furniture body.
2. Remove dust from the products with a slightly wet or special dry cloth without the use of chemical cleaning agents.
3. To avoid warping and discolouration, avoid exposing the furniture to direct sunlight.
4. Furniture is recommended to operate in rooms at a temperature of at least +2°C and relative humidity of 45-70%.
5. It is forbidden to put hot objects on all worktops and horizontal surfaces of furniture, defrost products or leave strongly cooled objects on the surface of the worktop for a long time.

MANUFACTURER'S WARRANTY

Warranty period:
Furniture - 24 months from the date of sale in the store. The product meets the requirements of GOST 16371-2014.
Furniture for sitting and lying down - 18 months from the date of sale in the store. The product meets the requirements of GOST 16371-2014, GOST 19917-2014.

During the warranty period, the manufacturer guarantees the repair of products or their replacement, if the consumer does not violate the operating rules.
Product lifetime of furniture and furniture for sitting and lying down is 2 years.